



WWTCATV10

[User Manual]

Please read and follow the installation and operating instructions provided.

Table of Contents

- I. Introduction 1
- II. Installation Instructions 2
 - Step #1 Lay out your frame
 - Step #2 Connect your 10 ft. toolbar
 - Step #3 Connect your Mounting Bracket to your toolbar
 - Step #4 Connect Toolbar Assembly to Mounting Brackets
 - Step #5 Attach assembly to desired equipment
 - Step #6 Connecting the Sponges
 - Step #7 Attaching your boom
 - Step #8 Plumbing and Manifold options
 - Step #9 Using the wiper with your sprayer and boom
- III. Operating Instructions10
 - Before You Start
 - Mixing Instructions
 - Field Adjustments
- IV. Maintenance Requirements.....12
 - Common Filter Maintenance
 - Operating At Freezing Temperatures
- V. Policies and Information13

IMPORTANT:

YOUR SMUCKER WEED WIPER COMES WITH A 2 YEAR MANUFACTURES WARRANTY. PLEASE SAVE YOUR RECEIPT FOR PROOF OF PURCHASE. CONTACT THE DEALER THAT YOU PURCHASES YOUR WIPER FORM WITH ANY WARRANTY ISSUES.

INTRODUCTION

Congratulations on your purchase of a Smucker Super Sponge® Weed Wiper!

The Super Sponge® is a lightweight, durable, herbicide applicator. Our sponges are designed to apply the maximum amount of product to the target weeds without any drift. The sponge applicators are made of industrial-strength, crusted sponge that stay saturated with chemical to wipe directly onto weeds. Our sponge weed wiper and top crop kits are applicators. Smucker Manufacturing makes no guarantee of any and all chemical use through the sponge application. Please read all chemical labeling concerning the weed wiper instructions.

The Super Sponge® has proven to be a quick and efficient way to wipe out weeds in your crops in many independent studies and we are confident you will be pleased with the results. We value our customers, and we would appreciate any input or comments you may have regarding your new Super Sponge® wiper.

You can visit our smuckermfg.net website page for reference to all weed wiper parts and diagrams. If you still have questions, give us a call and we can even help you locate your closest Smucker dealer.

Also, visit www.smuckermfg.net or ask your dealer about the other product lines we offer. We offer premium products at an affordable price. Take a look at our Foam Markers, Calf Warmers, and VisionWorks camera systems for farm equipment on our website.

www.smuckermfg.net

www.redweeder.com

www.visionworkscameras.com

Scan QR codes below with your smart phone

Mobile website for VisionWorks Cameras



Smucker Mobile website



Installation Instructions

Thank you for purchasing an ATV/Front Bucket Weed Wiper model. Please follow the directions provided carefully. We recommend assembling this unit with two people. You should expect a 1-1 ½ hours assembly time.

Please refer to your Parts Inventory Sheet when installing your Weed Wiper.

Step #1 Lay out your frame

Your ATV/Front Bucket Weed Wiper can be mounted on the front rack of your ATV, in the bed of your UTV, or on your front bucket (as pictured). Pull out your ATV weed wiper model parts and follow the directions below.



Step #2 Connect your 10' toolbar

NB3820



NB38LO



NB38NU



Connect your 5 ft. toolbar (WWFBTB) and 5 ft. toolbar extension (WWFBTB-E) together with your extension insert bar (WWFBTB-EI) as pictured. Use 3/8" x 2" bolts (NB3820 QTY: 4) with a washer and nut (NB38LO QTY: 4, NB38NU QTY: 4) to secure the toolbar and extension to the insert bar.

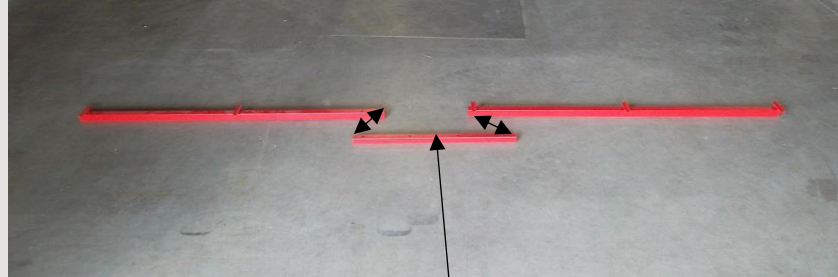

Extension Insert Bar

Step #3 Connect your Mounting Bracket to your toolbar

NB3825



NB38LO



NB38NU



Attach two 33" mounting brackets (WWFBMB-D) to your toolbar as pictured, using your front bucket mounting brackets tab (WWFBMB-T) and the 3/8" x 2 1/2" bolts provided (NB3825 QTY: 4) with the 3/8" lock washers (NB38LO QTY: 4) and 3/8" nuts (NB38NU QTY: 4). **Note: The metal bracket tabs pictured are not connected to your existing toolbar.**

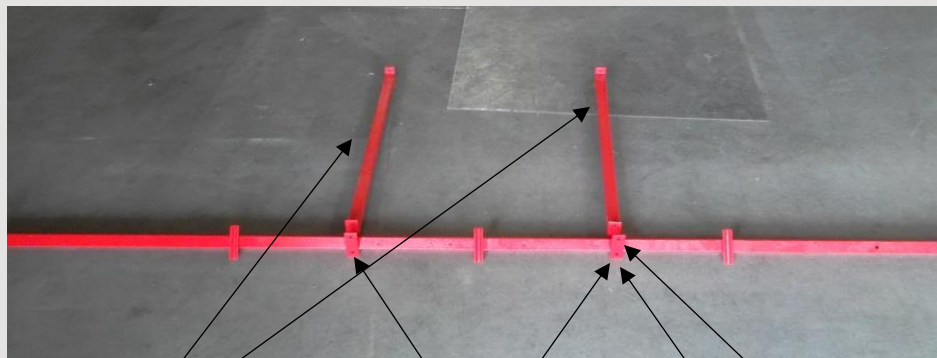

Mounting Brackets

Mounting Bracket Tabs

Bolt Inserts

Step #4 Connect Toolbar Assembly to Your Mounting Brackets

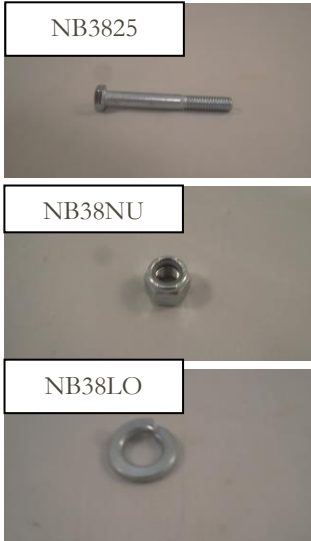

Attach your remaining two 33" mounting brackets (WWFBMB-D) to your bracket assembly as pictured, using your front bucket mounting bracket tabs (WWFBMB-T QTY: 2) and the 3/8" x 2 1/2" bolts provided (NB3825 QTY: 4) with the 3/8" lock washers (NB38LO QTY: 4) and 3/8" nuts (NB38NU QTY: 4).

Option #1 for ATV or UTV (see picture in Step #1 for visual directions)



Option #2 for Front Bucket Mount

(Diagram of brackets covered up by the picture below)

Attach your remaining brackets at your desired height for wiping. You can always loosen the bolts and adjust your height later.

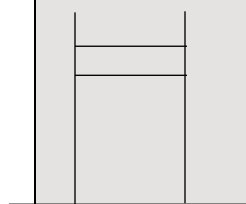

Toolbar

Step #5 Attach Assembly to your desired equipment

NBUB07



Option #1 Attach to your ATV

Use the U-Bolts provided (NBUB07 QTY: 4) to attach your toolbar to your ATV rack as pictured. Use two U-bolts on each metal toolbar.



Option #2 Attach to your UTV

You may choose to mount your toolbar to the back of your UTV bed. If you choose to do this, you will need to either drill a hole in your UTV bed, or strap down your toolbar. We also offer an optional UTV bracket if you would like to mount your Weed Wiper to the front of your UTV (pictures below). Please contact us for questions on this option.



Notice that the models pictured are 10 ft. models.



Option #3 Attach to your front Bucket

You may choose to mount your toolbar to your front bucket on your tractor. If you choose to do this, you will need to both drill a hole in your front bucket and use the U-bolts (NBUB07 QTY: 4) to mount your toolbar to your front bucket or you can also use your tie down straps to mount your tool bar.



NBUB07



Step #6 Connecting the Sponge Sections

The first step is to lay out each of the 30” sponge sections (WWTC30 QTY: 4) Connect them together as pictured with our PVC, “Tee” risers (WW2346-TC QTY: 5). **Do not worry, it’s okay to end your boom with a “Tee” since there is no chemical flow through the risers.**

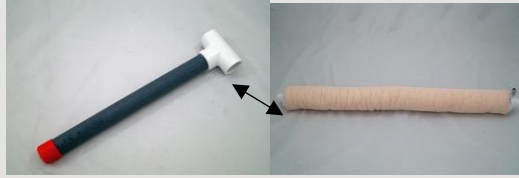

IMPORTANT: DO NOT glue your sponge sections into your PVC, “Tees.” Hammer them together with a mallet (as shown in the picture below). It’s **very important** that you connect your sponge sections with the push to connect elbow facing up (as pictured) with the blue mark on your white caps facing forward from your boom, in the direction you will wipe, at the one o’clock position (as pictured). Notice that your push to connect elbow will be on the same side for each of your sponges across your boom (as pictured next page).

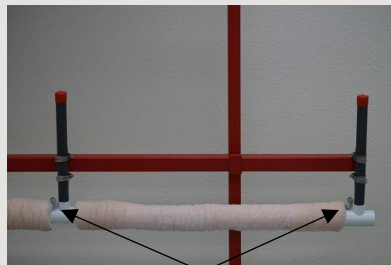
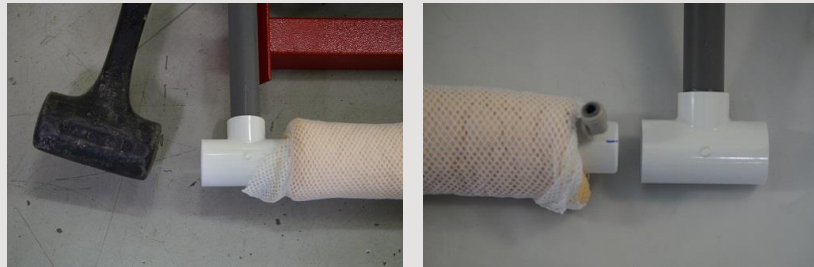

Push to Connect Elbow Facing Same Direction

Make sure, as you hammer in your elbow, that you get your sponge wet and hammer the elbow in until the edge of the cap reaches the center of the, “Tee.” After hammering in your risers, make sure you stretch your sponges out over your T-risers so that your boom is almost entirely covered by your sponges (Sponges must be wet to do this).

Step #7 Attaching your boom

From there simply clamp your, “Tee” riser onto the metal angle iron tabs with the clamps included CL0016 (QTY: 10). Make sure that you clamp each, “Tee” riser at the same height to ensure that your sponge boom is level (as pictured next page). Use two clamps per riser.

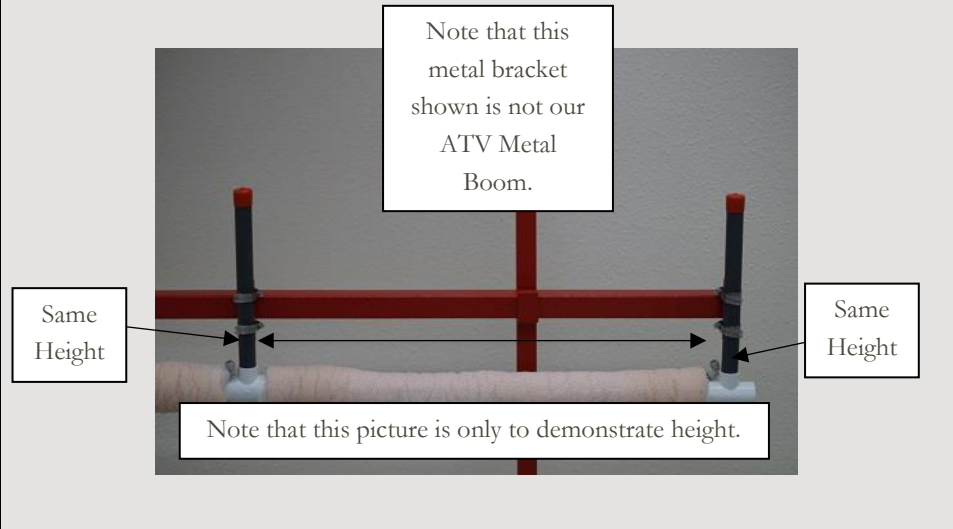

Step #8 Mounting your Manifold and plumbing your unit

Your kit comes with a manifold system (WWTCM4P), which connects to **your existing (not provided)** equipment pump outlet. First, mount the provided Manifold system (WWTCM4P) to the **CENTER** of your boom frame (i.e. the center of your weed wiper), as pictured, with the zip ties provided (NY108H QTY: 5). **If you do not mount to the center of your boom frame, the tubing cuts we recommend below will not reach all of your sponges.**

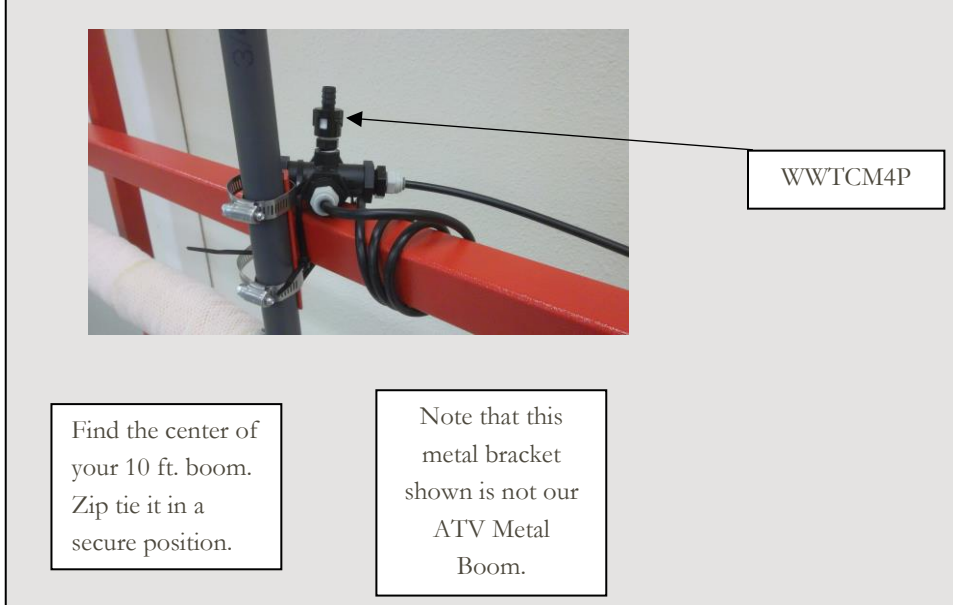

(Step #8 continued)

We **DO NOT** provide the pump needed to power our weed wiper. We recommend using a minimum 1.8 GPM per minute pump. We also **DO NOT** provide the vinyl tubing needed to run from your manifold to your pump because the length required will vary. Therefore, we expect that you will provide the 3/8 vinyl tubing supply line from your spray pump to the inlet of the manifold 3/8" Hose barb as pictured below. The length required will vary based on where your pump is located in comparison to the center of your boom where your manifold has just been mounted. Now, connect your manifold to your spray pump.



The manifold included has quick connectors to supply product to each of the 30" sponge section (in this case there are 4 ports). Use your WW1215 roll, and we suggest making cuts at (7 ft. QTY: 4) to plumb from your manifold to your individual sponge sections. **It's extremely important that each sponge assembly is supplied with the same length of tubing to ensure equal chemical flow.** Any extra tubing for the closer sponge sections can just be coiled up or zip tied down with the zip ties (NY108H) remaining (View picture below for a visual). Do not over tighten the zip ties and pinch the tubing.

Simply push the tubing into the quick connectors on both your sponge section, and your manifold (as pictured). The only way to remove the tubing is to hold down the grey ring around push to connect, while pulling out the tubing.

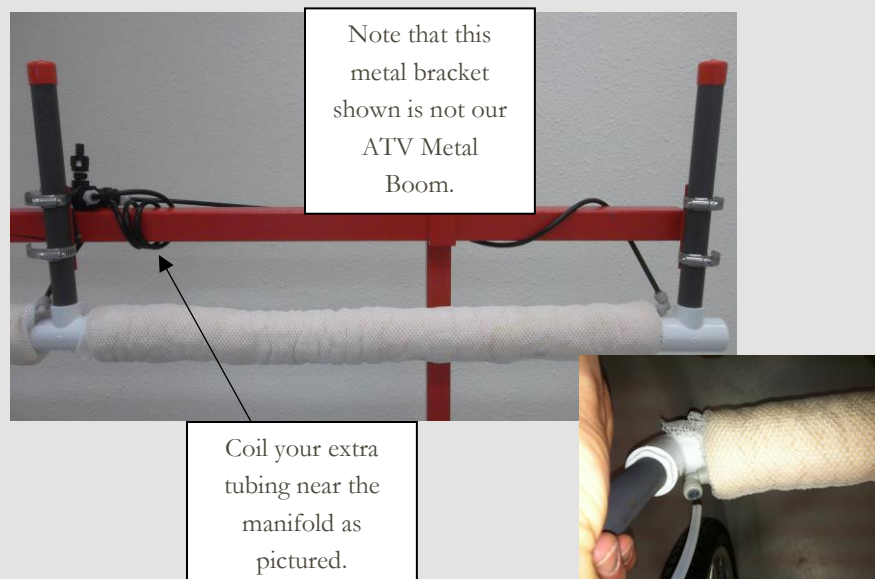

Step #9 Using the weed wiper with your sprayer and boom

It's very important to have a cleanable in-line filter on your sprayer to prevent small particles from plugging up the small outlets inside the sponge feed tubes (as pictured). Below we have pictured our in-line filters for purchase.



FM1032



FM0138

Make sure that you have a way to turn the pump on and off, because you will not run the pump continuously while using your weed wiper. This is usually done with a master on and off switch on your pump or through your boom section controls (depending on how you set up your plumbing). When the pump is on, the chemical will be pumped into the PVC, through small holes, and into the sponge. This pump fed system will ensure quick filling of the sponges and instant shut off since the system is pressurized.

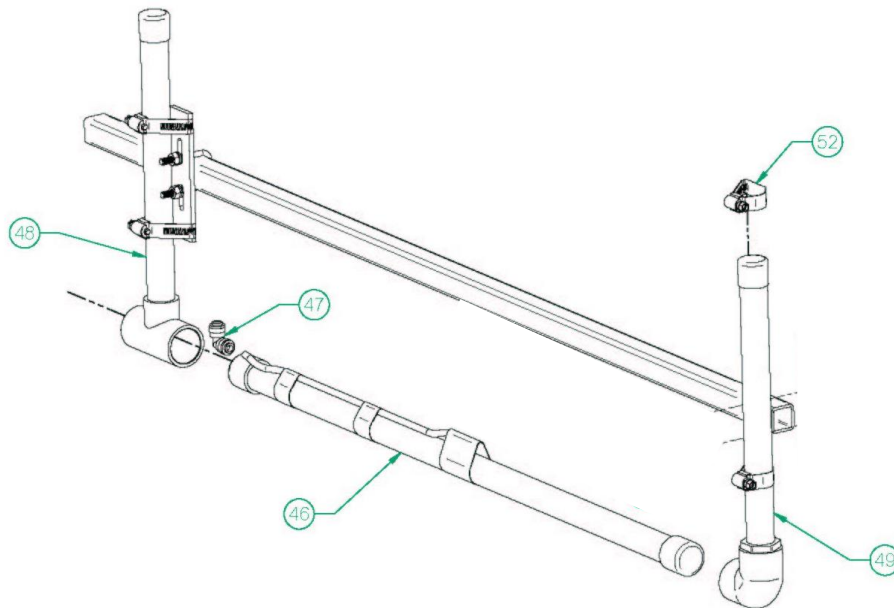

Operating Instructions

The ATV/Front Bucket Weed Wiper is a very effective contact herbicide applicator usually used to apply non-selective herbicides to weeds growing above crops. Proper set-up, adjustment, operation, and maintenance are essential to assure effective weed control while protecting the crop from herbicide damage.

Before You Start

1. Before you start using your sponge weed wiper in the field, always get the sponges wet with water. When sponges are dry, they are hard and less effective. Wetting your sponges with a garden hose before use, allows you to work out any dry spots before any application. We strongly recommend that you fill them up with water, and ring them out before turning on your chemical flow.
 2. Next, we recommend that you run water through your tank to check your sponges for even feeding. Therefore, before filling the tank with chemicals, put water in your tank and turn on your pump until you see the sponges dripping. Watch for even dripping throughout the full length of the wiper. Unlike a conventional sprayer, you cannot see plugged nozzles on a wiper during operation. Always check for uniform feeding before heading out into the field.
 3. Once even feeding is attained, drain your product tank by removing the 3/8" supply tubing from the black filter. Squeeze the excess water from the sponges and fill the tank with the chemical solution following our mixing instructions below. Then turn on your pump until you see the sponges fully saturated (almost dripping), which typically will only take a few seconds. Once your sponges are saturated, you are ready to go!
-

Mixing Instructions

The most common product to use in a wiper is Glyphosate. The manufacturing label recommends a 33% mix rate, however, please follow **your** label for mix rates in a wiping applicator/contact herbicide applicator. It's important to remember that the ratio of herbicide to water can vary depending on the weeds to be controlled, the time of year, and the temperature. Contact your chemical field man or extension service for best herbicide mix and or surfactant for specific weed and crop conditions.

If you are trying to control Glyphosate resistance weeds follow the label for Paraquat. The label, in most states for controlling Palmer Amaranth, is listed at a 50% mix rate. However, **always follow the label.**

Field Adjustments

Adjust the height of the sponges to just above crop level and contact as much of the weed as possible, without contacting the crop.

Turn on the master on/off switch only when you believe you need more chemical, only for a short amount of time, and begin wiping at 5-7 MPH. Try to maintain a proper level of product in the sponges to maintain good coverage without dripping. While you are still unfamiliar with turning the pump on and off to adjust the chemical flow, it's usually better to set the wiper too wet and have a little dripping, rather than have it set too dry and have poor weed kill.

Maintenance Requirements

Common Sponge Maintenance

The protective netting over the sponge is replaceable and is cheap to replace if you can replace the netting before the cellulose sponge is damaged. Therefore, we recommend that you check your sponges often for wear and tear.

If you need your sponge netting replaced, ask us for part number (WW2302). If you need your sponge replaced, ask us for part number (WW2301).

Storage Maintenance

Do not store the system over the off-season with chemical in the lines. A film will form on the tubing and can plug the small feedholes. Avoid this by flushing your system thoroughly with water at the end of the season. However, it's also advisable to flush the system with water and spray the sponges with water to remove chemical, which may cause the sponge to harden, after every use.

Check and clean the black filter as needed. At the end of the season, store your weed wiper in a dry place, out of direct sunlight.
