

Copyright. All information furnished within this document, electronic file or design correspondence is the property of Den Hartog industries, Inc. and shall not be used, disclosed to others or copied without the expressed written consent of Den Hartog Industries, Inc.

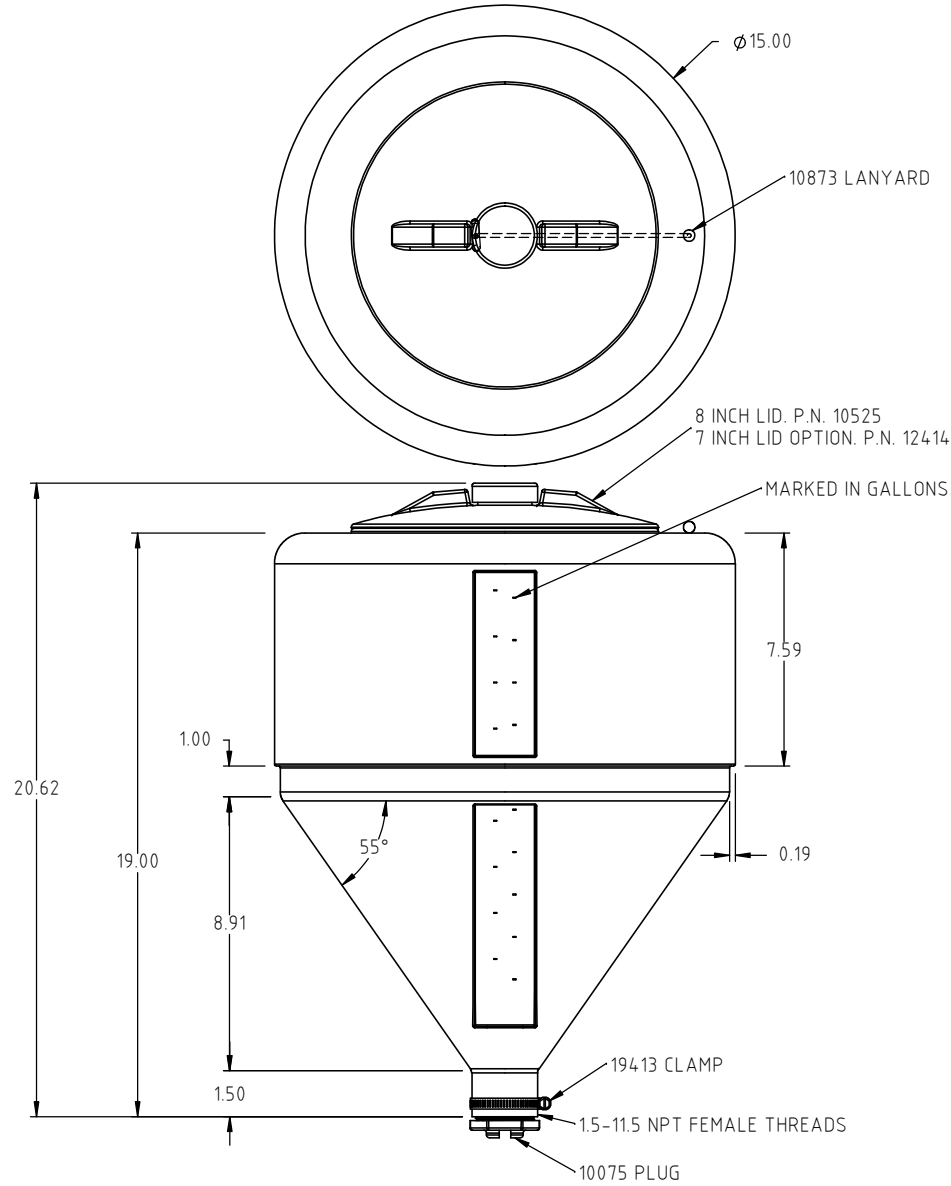

				DRAWN / DATE DHJ 10-18-13	MATERIAL 10418
				APPROD. / DATE REH 1/27/14	
REV	DESCRIPTION	BY / DATE	CCN	SHOT WEIGHT: 6.00 LBS	NOTES: 1.) 0.21" NOM. WALL
				SHIPPING WEIGHT: 8.00 LBS	
				FINISH:	
ALL DIMENSIONS ARE IN DECIMAL INCHES TOLERANCES UNLESS OTHERWISE SPECIFIED		THIRD ANGLE PROJECTION ANSI 14.5M			
POLYETHYLENE ±1% @ 68°F					
METAL DECIMAL ± .125" FRACTION ± 1/4" ANGLE ± 1°					



Den Hartog
INDUSTRIES, INC.

Acra Roto-Mold Injection Molding Blow Molding Sowjoy

4010 HOSPERS DRIVE S. BOX 425, HOSPERS, IOWA 51238-0425

DESCRIPTION 7 GALLON FULL DRAIN INDUCTOR TANK	
SCALE N.S.	PART NO. INFD7-15